

# TOSHIBA

Leading Innovation >>>

*AIR CONDITIONER (MULTI-SPLIT TYPE)*

## Installation Manual

---



### Outdoor Unit

Model name:

---

**RAS-5M34UAV-E**

**Contents**

<b>1</b>	<b>PRECAUTIONS FOR SAFETY</b> .....	<b>1</b>
<b>2</b>	<b>INSTALLATION/SERVICE TOOLS</b> .....	<b>2</b>
<b>3</b>	<b>SPECIFICATIONS</b> .....	<b>3</b>
<b>4</b>	<b>OPTIONAL PARTS, ACCESSORIES</b> .....	<b>3</b>
<b>5</b>	<b>INSTALLATION OF OUTDOOR UNIT</b> .....	<b>4</b>
<b>6</b>	<b>REFRIGERANT PIPING</b> .....	<b>5</b>
<b>7</b>	<b>ELECTRICAL WORK</b> .....	<b>7</b>
<b>8</b>	<b>GROUNDING</b> .....	<b>7</b>
<b>9</b>	<b>TEST OPERATION</b> .....	<b>8</b>

Please read this Installation Manual carefully before installing the Air Conditioner.

- This Manual describes the installation method of the outdoor unit.
- For installation of the indoor unit, refer to the Installation Manual attached to the indoor unit.



**IMPORTANT NOTICE**

For details on how to install the indoor units, refer to the installation manual accompanying the indoor units.

**1 PRECAUTIONS FOR SAFETY**

Be sure to read this installation manual carefully before installing.  
 The supplied CD-ROM contains the installation manual translated into many languages.  
 Recommend to the owner to perform maintenance periodically when using over long periods of time.

Be sure to follow the precautions provided here to avoid safety risks. The symbols and their meanings are shown below.

 <b>DANGER</b>	It indicates that incorrect use of this unit can result in a high possibility of severe injury(*1) or death.
 <b>WARNING</b>	It indicates that incorrect use of this unit may cause severe injury or death.
 <b>CAUTION</b>	It indicates that incorrect use of this unit may cause personal injury(*2), or property damage(*3).

- \*1: A severe injury refers to blindness, injury, burns (hot or cold), electrical shock, bone fracture, or poisoning that leaves after effects and requires hospitalization or extended out-patient treatment.
- \*2: Personal injury means a slight accident, burn, or electrical shock which does not require admission or repeated hospital treatment.
- \*3: Property damage means greater damage which affects assets or resources.

**For general public use**

Power supply cord of parts of appliance for outdoor use shall be at least polychloroprene sheathed flexible cord (design H07RN-F) or cord designation 60245 IEC66 (2.5 mm<sup>2</sup> or more). (Shall be installed in accordance with national wiring regulations.)  
 This appliance is not intended for use by person (including children) with reduced physical, sensory or mental capabilities, or lack of experience and knowledge, unless they have been given supervision or instruction concerning use of the appliance by a person responsible for their safety.  
 Children should be supervised to ensure that they do not play with the appliance.

 **CAUTION**

**New refrigerant air conditioner installation**  
 THIS AIR CONDITIONER USES THE NEW HFC REFRIGERANT (R410A), WHICH DOES NOT DESTROY THE OZONE LAYER.  
 R410A refrigerant is apt to be affected by impurities such as water, oxidizing membranes, and oils because the pressure of R410A refrigerant is approx. 1.6 times of refrigerant R22. As well as the adoption of this new refrigerant, refrigerating machine oil has also been changed. Therefore, during installation work, be sure that water, dust, former refrigerant, or refrigerating machine oil does not enter the refrigeration cycle of a new-refrigerant air conditioner. To avoid mixing refrigerant and refrigerating machine oil, the sizes of charging port connecting sections on the main unit are different from those for the conventional refrigerant, and different size tools are also required. For connecting pipes, use new and clean piping materials with high pressure withstand capabilities, designed for R410A only, and ensure that water or dust does not enter. Moreover, do not use any existing piping as its pressure withstand may be insufficient and may contain impurities.

 **DANGER**

- FOR USE BY QUALIFIED PERSONS ONLY.
- MEANS FOR DISCONNECTION FROM THE SUPPLY HAVING A CONTACT SEPARATION OF AT LEAST 3 mm IN ALL POLES MUST BE INCORPORATED IN THE FIXED WIRING.
- TURN OFF MAIN POWER SUPPLY BEFORE ATTEMPTING ANY ELECTRICAL WORK. MAKE SURE ALL POWER SWITCHES ARE OFF. FAILURE TO DO SO MAY CAUSE ELECTRIC SHOCK.
- CONNECT THE CONNECTING CABLE CORRECTLY. IF THE CONNECTING CABLE IS CONNECTED WRONGLY, ELECTRIC PARTS MAY BE DAMAGED.
- CHECK THE EARTH WIRE THAT IT IS NOT BROKEN OR DISCONNECTED BEFORE INSTALLATION.
- DO NOT INSTALL NEAR CONCENTRATIONS OF COMBUSTIBLE GAS OR GAS VAPORS. FAILURE TO FOLLOW THIS INSTRUCTION CAN RESULT IN FIRE OR EXPLOSION.
- TO PREVENT OVERHEATING THE INDOOR UNIT AND CAUSING A FIRE HAZARD, PLACE THE UNIT WELL AWAY (MORE THAN 2 M) FROM HEAT SOURCES SUCH AS RADIATORS, HEATERS, FURNACE, STOVES, ETC.
- WHEN MOVING THE AIR CONDITIONER FOR INSTALLING IT IN ANOTHER PLACE AGAIN, BE VERY CAREFUL NOT TO GET THE SPECIFIED REFRIGERANT (R410A) WITH ANY OTHER GASEOUS BODY INTO THE REFRIGERATION CYCLE. IF AIR OR ANY OTHER GAS IS MIXED IN THE REFRIGERANT, THE GAS PRESSURE IN THE REFRIGERATION CYCLE BECOMES ABNORMALLY HIGH AND IT RESULTINGLY CAUSES BURST OF THE PIPE AND INJURIES ON PERSONS.
- IN THE EVENT THAT THE REFRIGERANT GAS LEAKS OUT OF THE PIPE DURING THE INSTALLATION WORK, IMMEDIATELY LET FRESH AIR INTO THE ROOM. IF THE REFRIGERANT GAS IS HEATED BY FIRE OR SOMETHING ELSE, IT CAUSES GENERATION OF POISONOUS GAS.
- WHEN INSTALLING OR RE-INSTALLING THE AIR CONDITIONER, DO NOT INJECT AIR OR OTHER SUBSTANCES BESIDES THE DESIGNATED REFRIGERANT "R410A" INTO THE REFRIGERATING CYCLE. IF AIR OR OTHER SUBSTANCES ARE MIXED, AN ABNORMAL PRESSURE CAN OCCUR IN THE REFRIGERATING CYCLE, AND THIS CAN CAUSE AN INJURY DUE TO A PIPE RUPTURE.

**⚠ WARNING**

- Installation work must be requested from the supplying retail dealership or professional vendors. Self-installation may cause water leakage, electrical shock, or fire as a result of improper installation.
- Specified tools and pipe parts for model R410A are required, and installation work must be done in accordance with the manual. HFC type refrigerant R410A has 1.6 times more pressure than that of conventional refrigerant (R22). Use the specified pipe parts, and ensure correct installation, otherwise damage and/or injury may be caused. At the same time, water leakage, electrical shock, and fire may occur.
- Be sure to install the unit in a place which can sufficiently bear its weight. If the load bearing of the unit is not enough, or installation of the unit is improper, the unit may fall and result in injury.
- Electrical work must be performed by a qualified electrical engineer in accordance with the code governing such installation work, internal wiring regulations, and the manual. A dedicated circuit and the rated voltage must be used. Insufficient power supply or improper installation may cause electrical shock or fire.
- Use a cabletyre cable to connect wires in the indoor/outdoor units. Midway connection, stranded wire, and single-wire connections are not allowed. Improper connection or fixing may cause a fire.
- Wiring between the indoor unit and outdoor units must be well shaped so that the cover can be firmly placed. Improper cover installation may cause increased heat, fire, or electrical shock at the terminal area.
- Be sure to use only approved accessories or the specified parts. Failure to do so may cause the unit to fall, water leakage, fire or electrical shock.
- After the installation work, ensure that there is no leakage of refrigerant gas. If the refrigerant gas leaks out of the pipe into the room and is heated by fire or something else from a fan heater, stove or gas range, it causes generation of poisonous gas.
- Make sure the equipment is properly earthed. Do not connect the earth wire to a gas pipe, water pipe, lightning conductor, or telephone earth wire. Improper earth work may be the cause of electrical shock.
- Do not install the unit where flammable gas may leak. If there is any gas leakage or accumulation around the unit, it can cause a fire.
- Do not select a location for installation where there may be excessive water or humidity, such as a bathroom. Deterioration of insulation may cause electrical shock or fire.
- Installation work must be performed following the instructions in this installation manual. Improper installation may cause water leakage, electrical shock or fire. Check the following items before operating the unit.
  - Be sure that the pipe connection is well placed and there are no leaks.
  - Check that the service valve is open. If the service valve is closed, it may cause overpressure and result in compressor damage. At the same time, if there is a leak in the connection part, it may cause air suction and overpressure, resulting in burst or injury.
- The following must be certainly done during pump down.
  - Do not incorporate air into the refrigeration cycle.
  - Close the 2 service valves. Stop the compressor and remove the refrigerant pipe.
 If the refrigerant pipe is removed when the compressor is operating and service valves are opened, the refrigerant cycle will inhale unwanted matter such as air and the pressure in the cycle becomes abnormally elevated. It may cause a burst or injury.
- Do not modify the power cable, connect the cable midway, or use a multiple outlet extension cable. Doing so may cause contact failure, insulation failure, or excess current, resulting in fire or electrical shock.
- If you detect any damage, do not install the unit. Contact your supplying dealer immediately.
- Never modify this unit by removing any of the safety guards or bypassing any of the safety interlock switches.

**⚠ CAUTION**

- Please read this installation manual carefully before installing the unit. It contains further important instructions for proper installation.
- Exposure of unit to water or other moisture before installation could result in electric shock. Do not store it in a wet basement or expose to rain or water.
- After unpacking the unit, examine it carefully for possible damage.
- Do not install in a place that can increase the vibration of the unit. Do not install in a place that can amplify the noise level of the unit or where noise and discharged air might disturb neighbours.
- This appliance must be connected to the main power supply by means of a circuit breaker depending on the place where the unit is installed. Failure to do so may cause electrical shock.
- Follow the instructions in this installation manual to arrange the drain pipe for proper drainage from the unit. Ensure that drained water is discharged. Improper drainage can result in water leakage, causing water damage to furniture.
- Tighten the flare nut with a torque wrench using the prescribed method. Do not apply excess torque. Otherwise, the nut may crack after a long period of usage and it may cause the leakage of refrigerant.
- Wear gloves (heavy gloves such as cotton gloves) for installation work. Failure to do so may cause personal injury when handling parts with sharp edges.
- Do not touch the air intake section or the aluminium fins of the outdoor unit. It may cause injury.
- Do not install the outdoor unit in a place which can be a nest for small animals. Small animals could enter and contact internal electrical parts, causing a failure or fire.
- Request the user to keep the place around the unit tidy and clean.
- Make sure to conduct a trial operation after the installation work, and explain how to use and maintain the unit to the customer in accordance with the manual. Ask the customer to keep the operation manual along with the installation manual.

**REQUIREMENT OF REPORT TO THE LOCAL POWER SUPPLIER**

Please make absolutely sure that the installation of this appliance is reported to the local power supplier before installation. If you experience any problems or if the installation is not accepted by the supplier, the service agency will take adequate countermeasures.

**2 INSTALLATION/SERVICE TOOLS****Changes in the product and components**

In air conditioners using R410A, in order to prevent any other refrigerant from being accidentally charged, the service port diameter size of the outdoor unit service valve has been changed. (1/2 UNF 20 threads per inch)

- In order to increase the pressure resisting strength of the refrigerant piping, flare processing diameter and opposing flare nuts sizes have been changed. (for copper pipes with nominal dimensions 1/2 and 5/8)

Gauge manifold for R410A	Phillips screwdriver	Pipe cutter	Flare tool for R410A
Charge hose for R410A	Level	Torque wrench	4mm hexagonal wrench
Vacuum pump for R410A	Scale	Wrench (or spanner)	
Gas leakage detector for R410A	Utility knife	Reamer	

### 3 SPECIFICATIONS

Operating conditions *1	Cooling operation	10 to 43°C
	Dry operation	10 to 43°C
	Heating operation	-10 to 22°C
Dimension	Height	890mm
	Width	900mm
	Depth	320mm
Net weight		75kg
Refrigerant R410A		2.99kg
Power supply		1ph, 50Hz, 220-240V 1ph, 60Hz, 220V
Maximum running current		19.5A
Installation fuse rating		20 A breaker or fuse (all types can be used)
Power cord (H07RN-F or 60245IEC66)		3-core 2.5mm <sup>2</sup>
Connecting cable (H07RN-F or 60245IEC66)		4-core 1.0mm <sup>2</sup>
Pipe length	Minimum for 1 unit	3m
	Maximum for 1 unit	25m
	Maximum for total unit *2	80m
	Height difference	15m
	No additional refrigerant charge	40m
Refrigerant adjustment		20g/m (41m-80m)

The specifications for performance of this air conditioner differs depending on the combination of the indoor units which are operated.

The information in this specifications table applies for the combinations with the catalogue.

For operation, read the owner's manual packed with the indoor unit.

Equipment complying with IEC 61000-3-12.

\*1 If the air conditioner is used in conditions other than the above, the safety protection functions may be activated.

\*2 If any 4-way cassette type is connected, the maximum for total unit pipe length is 40m.

#### Table of models that can be connected

○: Can be connected.

Indoor unit specification	Type	High Wall												Slim Duct			4-way Cassette			Console		
	Air purifying unit	yes												no								
	Nick name	DAISEIKAI 5												DFS 1								
	class (abbreviation)	10	13	16	18	10	13	16	18	07	10	13	16	10	13	16	10	13	16	10	13	18
Model name	RAS-M10PKVP-E	RAS-M13PKVP-E	RAS-M16PKVP-E	RAS-M18PKVP-E	RAS-M10PKVP-ND	RAS-M13PKVP-ND	RAS-M16PKVP-ND	RAS-M18PKVP-ND	RAS-M07SKV-E	RAS-M10SKV-E	RAS-M13SKV-E	RAS-M16SKV-E	RAS-M10GDV-E	RAS-M13GDV-E	RAS-M16GDV-E	RAS-M10SMUV-E	RAS-M13SMUV-E	RAS-M16SMUV-E	RAS-B10UFV-E	RAS-B13UFV-E	RAS-B18UFV-E	
Outdoor unit for combination	RAS-5M34UAV-E	○	○	○	○	○	○	○	○	○	○	○	○	○	○	○	○	○	○	○	○	○

	Indoor unit class	Standard connecting pipe diameter
E	07 or 10 or 13	6.35, 9.52mm
D	07 or 10 or 13	6.35, 9.52mm
C	07 or 10 or 13 or 16	6.35, 9.52mm
B	07 or 10 or 13 or 16 or 18	6.35, 12.7mm
A	07 or 10 or 13 or 16 or 18	6.35, 12.7mm
Total	68	—

All combinations that do not exceed the "Total" number can be installed.  
 More than 2 indoor units must be connected to an outdoor unit.  
 When 2 indoor units are connected to an outdoor unit, note that some combinations of indoor units are not compatible. For the further details, refer to the catalogue.  
 Only one 18-class indoor unit can be installed.





### 4 OPTIONAL PARTS, ACCESSORIES

#### Optional parts

Parts name	Specifications			Q'ty
Refrigerant piping *3	Indoor unit (abbreviation)	Liquid side (O.D.)	Gas side (O.D.)	1 ea.
	07, 10, 13	6.35mm	9.52mm	
	16, 18	6.35mm	12.7mm	
Putty, PVC tapes				1 ea.

\*3 Refrigerant piping covered with insulating material (Polyethylene form, 6mm thick) When duct-type or cassette-type unit is to be installed, it shall be covered with thicker insulating material (Polyethylene form, 10mm thick)

#### Accessories

Installation manual	1		Rubber cap (Water-proof)	5		CD-ROM (Installation manual)	1		F-GAS label	1		Drain nipple	1	
---------------------	---	---	--------------------------	---	---	------------------------------	---	---	-------------	---	---	--------------	---	---

## 5 INSTALLATION OF OUTDOOR UNIT

### ■ Installation Location

- A place which can bear the weight of the outdoor unit and does not cause an increase in noise level and vibration.
- A place where the operation noise and air discharge do not disturb neighbours.
- A place which is not exposed to strong wind.
- A place free of combustible gas.
- A place which does not block a passageway.
- A place where the drain water does not cause any problems.
- A place where there are no obstructions near its air intake or air outlet.

Installation in the following places may result in trouble:

- A place with a lot of machine oil.
- A place with saline-rich atmosphere such as a coastal area.
- A place with high level of sulfide gas.
- A place where high-frequency waves are likely to be generated, such as from audio equipment, welders, or medical equipment.

Do not install the unit in such places.

### ■ Precautions for Installation

- When the outdoor unit is to be installed in an elevated position, be sure to secure its feet.
- If the outdoor unit is to be mounted on a wall, make sure the base plate supporting it is sturdy enough.
- The base plate should be designed and manufactured to maintain its strength over a long d of time, and sufficient consideration should be given to ensure that the outdoor unit will not fall.
- When the outdoor unit is installed in a place that is always exposed to strong wind such as a coastal area or on a high story of a building, secure the normal fan operation using a duct or a wind shield.
- Especially in windy areas, install the unit in such a way as to prevent the admission of wind.
- When the outdoor unit is to be mounted high on a wall, take particular care to ensure that parts do not fall, and that the installer is protected.
- When doing installation work at ground level, it is usual to make wiring and pipe connections to the indoor units first, and then to make connections to the outdoor units.  
However, if outdoor work is difficult you can change the procedure. For example, by making adjustments to the wiring and piping lengths on the inside (rather than the outside).

### Necessary Space for Installation

If you need to install the outdoor unit in a location where there are some obstructions or a wall, secure sufficient space as shown in the figure below. The cooling/heating effect may be reduced by 10%.

#### Upper side view (Unit: mm)

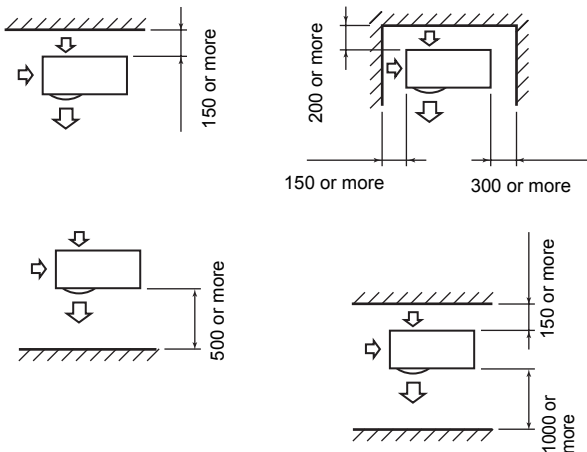

#### Side view (Unit: mm)

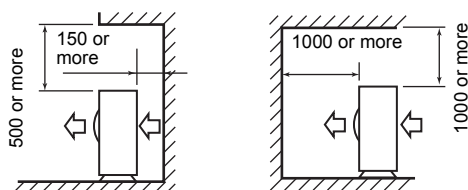

### Draining Off the Water from the Outdoor Unit

Install 5 waterproof rubber caps and the drain nipple to drain off the water from the outdoor unit.

- Seal the knock-out holes and screw/thread areas tightly using a silicon adhesive or a caulking compound.
- Use a drain pan to apply a centralized drain.

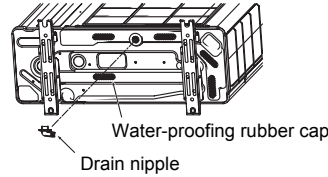

### Installation in Regions with Snowfall and Cold Temperatures

Do not use waterproof rubber caps or a drain nipple.

- If you need to install the outdoor unit in a location where there is a possibility of the drain freezing, pay close attention so that the drain does not become frozen.
- To protect the outdoor unit from snow, install the outdoor unit on a holding frame, and attach a snow protection hood and plate.
- Keep the outdoor unit at least 500mm above the snow accumulation line.

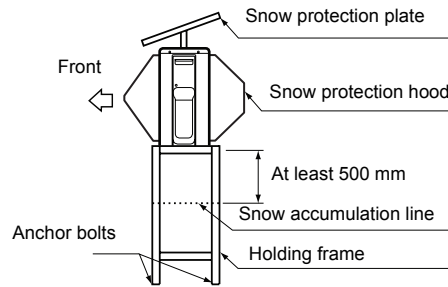

### Fixing the Outdoor Unit

Fix the outdoor unit using attachment bolts.

- Use 8mm or 10mm anchor bolts and nuts.
- Do not allow the attachment bolts to protrude by more than 15mm.
- Install the outdoor unit at ground level.
- Attach the vibration-proof rubber pads under the fixing legs.

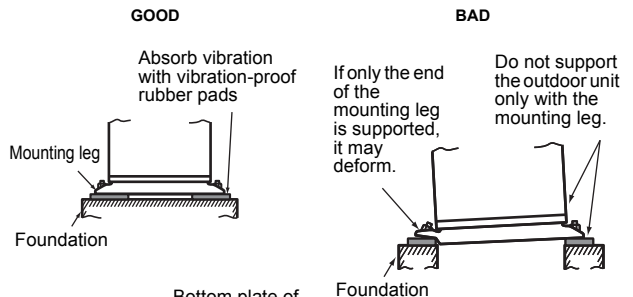
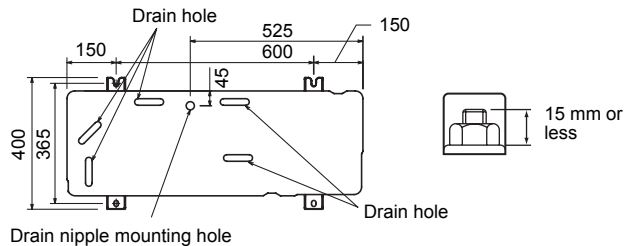

Bottom plate of outdoor unit

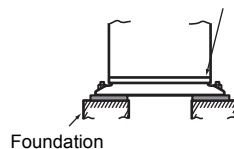

Support the bottom surface of the mounting leg that is in contact with and underneath the bottom plate of the outdoor unit.

## 6 REFRIGERANT PIPING

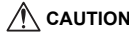

Install in rooms that are 13 m<sup>3</sup> or larger. If a leak of refrigerant gas occurs inside the room, an oxygen deficiency may occur.

### ■ Detaching the Front Panel

Remove the 5 screws.

- Pull out the front panel according to the direction of the arrows on the illustration below.

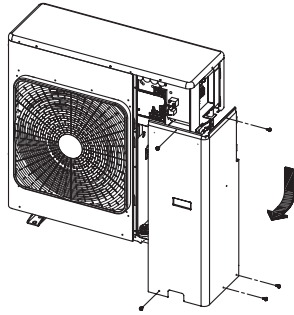

### ■ Refrigerant Piping Connection

#### Flaring

1. Cut the pipe with a pipe cutter.



2. Remove the burr inside of the pipe. When removing the burr, be careful so that chips do not fall into the pipe.
3. Remove the flare nuts attached to the outdoor/indoor unit, then insert them into each of the pipes.
4. Flare the pipes. See the following table for the projection margin (A) and flaring size (B).

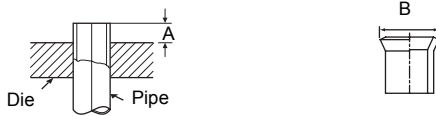

Pipe		A		B	Flare Nut		
Outside diameter	Thickness	Rigid (clutch type) R410A tool	Imperial (wing nut type) R410A tool		Width across flat	Tighten torque	
mm	mm	mm	mm	mm	mm	N•m	kgf•m
6.35	0.8	0 to 0.5	1.5 to 2.0	9.1	17	14 to 18	1.4 to 1.8
9.52	0.8	0 to 0.5	1.5 to 2.0	13.2	22	33 to 42	3.3 to 4.2
12.7	0.8	0 to 0.5	2.0 to 2.5	16.6	26	50 to 62	5.0 to 6.2

#### Pipe connection

1. Make wire and pipe connections for each indoor unit separately.
2. Align the centres of the connecting pipes and tighten the flare nut as much as possible with your fingers, then tighten the nut using a torque wrench. Be sure to tighten the nut at the specified torque value.
  - If you use one outdoor unit for several indoor units of a different class, connect the largest one first A, then connect the rest in the order B to E.
  - Do not remove the flare nuts for any ports you are not going to use for connection.
  - Do not leave the flare nut unattached for a long period of time.
  - Use a different-diameter joint if the diameters of the connection port and connection piping are different.
  - Mount the different-diameter joint on the connection port of the outdoor unit.

### ■ Air Purge

From the sake of environmental protection, use a vacuum pump to extract the air during installation.

- \* Prepare a 4mm hexagon wrench.

1. Connect a charge hose.
  - Make sure that the Handle Hi of the gauge manifold valve is closed fully.
  - Connect the port of the gauge manifold valve and the service port (Valve core (Setting Pin)) using the charge hose.

#### NOTE

If a control valve or charge valve is attached to the charge hose, leak of R410A refrigerant can be avoided.

2. Open the Handle Low of the gauge manifold valve fully, then operate the vacuum pump.
  - Loosen the flare nut of the at the gas end a little to make sure that air is taken in, then tighten the nut.
  - If you find air is not taken in, make sure that the charge hose is connected to the port(s) securely.
  - Perform extraction for about 40 minutes and make sure that the compound pressure gauge reading is -101kPa (-76cmHg).
  - If the compound pressure gauge reading is not -101kPa (-76cmHg), there is a possibility air is being taken in from the port(s).
  - Make sure that the charge hose is connected to the port(s) securely.
3. Close the Handle Low of the gauge manifold valve fully, then stop operating the vacuum pump.
  - Leave the gauge and pump as they are for 1 or 2 minutes, then make sure that the compound pressure gauge reading stays at -101kPa (-76cmHg).
  - You need not add refrigerant if the piping length is 40m or less. If the length exceeds 41m, add 20g of refrigerant per 1meter over.
4. Disconnect the charge hose from the service port, then open the valve stem fully using a 4mm hexagon wrench.

Hexagon wrench is required.

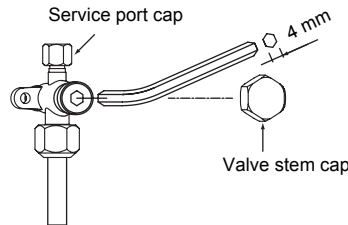

5. Tighten the service valve stem cap and service port cap securely.



Use a torque wrench and tighten the nut at the specified torque value.

6. Tighten all the caps on the valves securely, then perform a gas leak inspection.

Service valve	Tighten torque			
	Valve stem cap		Service port cap	
mm	N•m	kgf•m	N•m	kgf•m
Liquid side (9.52)	33 to 42	3.3 to 4.2	—	—
Gas side (12.7)	33 to 42	3.3 to 4.2	14 to 18	1.4 to 1.8

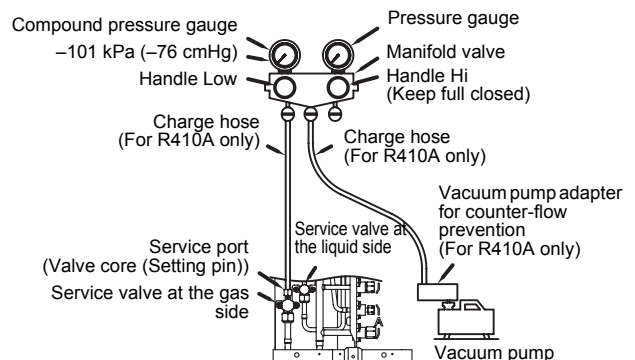

### ■ Charging Refrigerant

- You need not add refrigerant if the piping length is 40m or less.
- If the length exceeds 41m, add 20g of refrigerant per 1 meter over.

#### Procedure to Charge Refrigerant

After extraction is complete, close the valves, then charge the refrigerant.

- Make sure that no operations are in progress while charging the refrigerant.

If you cannot charge the refrigerant fully, add it from the service port of the service valve at the gas end while cooling operation is in progress.

**NOTE**

- Charge the refrigerant in a liquid state.
- If you charge the refrigerant in a gas state, the air conditioner will not operate properly since the refrigerant undergoes a change in its composition.

### Precautions for Adding Refrigerant

- Use a scale with a precision of at least 10 g per index line when adding the refrigerant.  
Do not use bathroom scales or similar instruments.
- Use liquid refrigerant when refilling.  
Since the refrigerant is in liquid form, it can fill up quickly.  
Therefore add the refrigerant gradually.



This product contains fluorinated greenhouse gases covered by the Kyoto Protocol.

- Chemical Name of Gas : R410A
- Global Warming Potential (GWP) of gas : 1975

1. Stick the enclose refrigerant label adjacent to the charging and/or recovering location.
2. Clearly write the charge refrigerant quantity on the refrigerant label using indelible ink.
3. Prevent emission of the contained fluorinated greenhouse gas. Ensure that the fluorinated greenhouse gas is never vented into the atmosphere during installation, service or disposal. If any leakage of the contained fluorinated greenhouse gas is detected, the leak must be stopped and repaired as soon as possible.
4. Only qualified service personnel are allowed to access and service this product.
5. Any handling of the fluorinated greenhouse gas in the product, such as when moving the product or recharging the gas, must comply with (EC) Regulation No.842/2006 on certain fluorinated greenhouse gases and any relevant local legislation.
6. Contact dealers, installers, etc., for any questions.

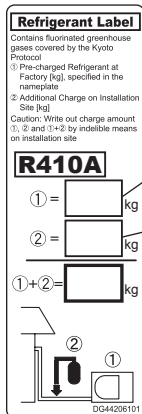

- ① Pre-charged Refrigerant at Factory [kg], specified in the nameplate
- ② Additional Charge on Installation Site [kg]

Periodical inspections for refrigerant leaks may be required depending on European or local legislation.

### ■ Insulation of the Refrigerant Pipes

- Insulate the refrigerant pipes for liquid and gas separately.

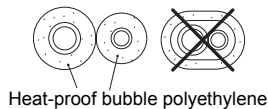

Underground piping: 10t (Laying the pipes on the wall, ceiling, or under the floor)

### ■ Gas Leak Inspection

- Perform a gas leak inspection for the flare nut connections, valve stem connection, and service port cap without fail.
- Use a leak detector exclusively manufactured for R410A.

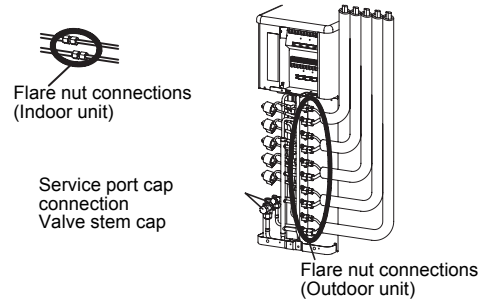

### ■ Performing Additional Installation of an Indoor Unit

1. Collect refrigerant from the outdoor unit.
2. Turn off the circuit breaker.
3. Perform additional installation referring to the procedure from "Refrigerant Piping Connection" on the previous page.

### ■ Pump-down Operation (Recovering refrigerant)



Since the forcible running for collecting refrigerant stops automatically after 10 minutes, finish collecting refrigerant within 10 minutes.



Electric current is applied on the control board. Beware of electric shock.

- The following must be certainly done during pump down.
    - Do not incorporate air into the refrigeration cycle.
    - Close the 2 service valves. Stop the compressor and remove the refrigerant pipe.
- If the refrigerant pipe is removed when the compressor is operating and service valves are opened, the refrigerant cycle will inhale unwanted matter such as air and the pressure in the cycle becomes abnormally elevated. It may cause a burst or injury.

1. Detach the front panel.  
Do not remove the air discharge grille.
2. Connect the charge hose to the service port.
3. Turn on the power.
4. Start running all the indoor units connected to the outside unit in the cooling mode.
5. Press the SW800 button on the P.C board MCC 5071 for 10 to 60 seconds to start the indoor unit(s) in the cooling mode forcibly.
  - When the status of each LED changes to that shown on the "While holding a button (10 to 60 seconds)" row on the table below, release the button. The status of each LED on the P.C board MCC 5071 changes.

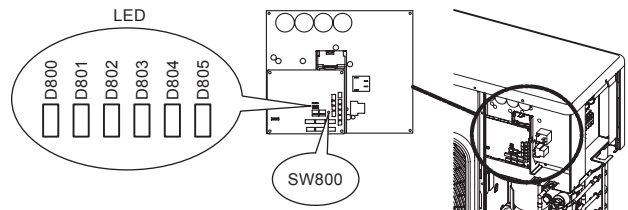

☒ : LED ON, ● : LED OFF, ◎ : LED Flash

	LED					
	D800	D801	D802	D803	D804	D805
Normal operation	☒	●	●	●	●	●
While holding a button (0 to 10 seconds)	☒	☒	☒	☒	☒	◎
While holding a button (10 to 60 seconds)	☒	☒	☒	◎	◎	◎
Release a button	◎	☒	☒	◎	◎	◎

6. Close the valve stem of the service valve at the liquid end.
7. Make sure that the compound pressure gauge reading is -101kPa (-76cmHg).
8. Close the valve stem of the service valve at the gas end.
9. Stop running all the indoor units.

## 7 ELECTRICAL WORK

### ⚠ WARNING

- Be sure to comply with local regulations/codes when running the wire from the outdoor unit to the indoor unit.  
(Size of wire and wiring method etc.)
- A lack of electrical capacitance or incorrect wiring may cause an electric shock or a fire.
- To make sure that the wiring connection are secure, use designated cables.  
Fix the cables securely so that no external force applied to the cables may effect the terminals.
- If wiring connections are incomplete or cables are not fixed securely, it may cause a fire.
- Be sure to ground the outdoor unit.
- Incomplete grounding may lead to an electric shock.

### ⚠ CAUTION

- Use a circuit breaker of a type that is not tripped by shock waves.
- Incorrect/incomplete wiring will cause electrical fires or smoke.
- Prepare the power source for exclusive use with the air conditioner.
- This product can be connected to the main power.  
Fixed wire connections:  
A switch that disconnects all poles and has a contact separation of at least 3 mm must be incorporated into the fixed wiring.

### ■ Wire Connection

- The dash lines show on-site wiring.

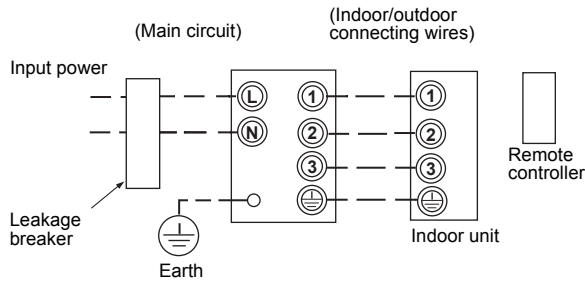

- Connect the indoor/outdoor connecting cables to the identical terminal numbers on the terminal block of each unit.
  - Incorrect connection may cause a failure.
1. Detach the front panel from the outdoor unit.
  2. Remove the cord clamp.
  3. Connect the wires for the power source and each indoor unit.  
• Connect the connecting cable to the terminal as identified by the matching numbers on the terminal block of the indoor and the outdoor unit.
  4. Fix the wiring connections for the power source and each indoor unit securely using a cord clamp.
  5. Attach the front panel to the outdoor unit.

### Stripping Length of connecting cable for outdoor unit

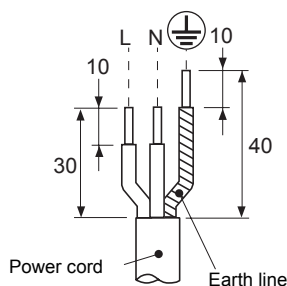
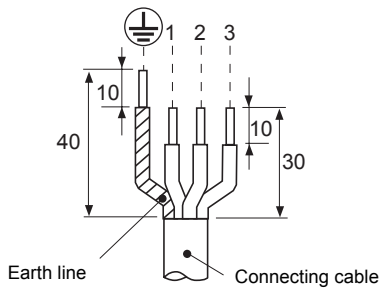

Terminal block (Connecting cable)

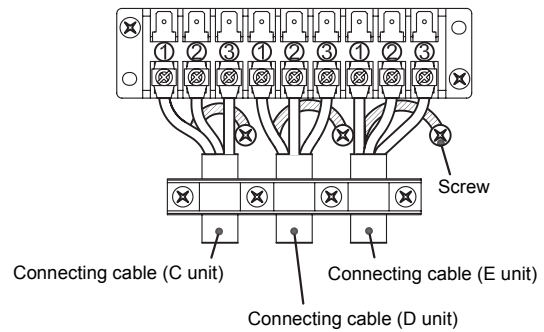
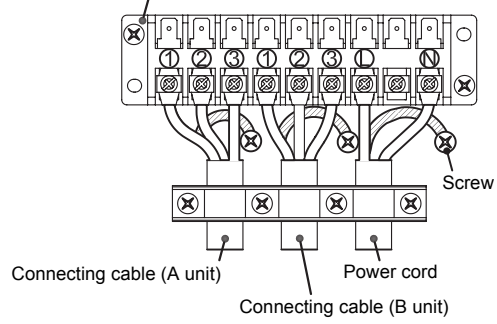

## 8 GROUNDING

### This air conditioner must be grounded without fail.

- Grounding is necessary not only to safeguard against the possibility of receiving an electric shock but also to absorb both static, which is generated by high frequencies and held in the surface of the outdoor unit, and noise since the air conditioner incorporates a frequency conversion device (called an inverter) in the outdoor unit.
- If the air conditioner is not grounded, users may receive an electric shock if they touch the surface of the outdoor unit and that unit is charged with static.

## 9 TEST OPERATION

### ■ Wiring/Piping Check



**⚠ Electric current is applied on the control board. Beware of electric shock.**

1. Detach the front panel of the outdoor unit.  
Do not remove the air discharge grille.
2. Turn on the circuit breaker to supply electricity.
3. Start running all the indoor units connected to the outside unit in the cooling mode.
  - You need not specify the temperature setting of the indoor units.
  - You cannot check wiring/piping when the external temperature is 5°C or less.
4. Turn on the SW802 No.4 switch on the P.C board MCC 5071.  
The wiring/piping check starts automatically.  
While checking, each LED flashes consecutively to indicate that the checking each indoor unit is in progress.  
When checking is complete, the check result is displayed on the LED panel. See the table below for details.
  - 4-1. If no problems are detected, The checking operation returns to the normal operation automatically.  
The compressor stops temporarily, then it restarts.  
The D801 LED flashes while the compressor is stopped.
  - 4-2. If incorrect wiring/piping is detected, The checking operation stops.  
Check the status of the LED to confirm the details of the problem.  
Turn off the circuit breaker, then check wiring/piping again.
5. Turn off the SW802 No.4 switch on the P.C board MCC 5071.
  - The checking operation changes to the normal operation.

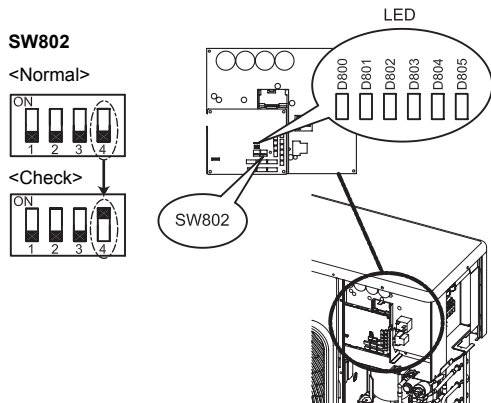

⊠ : LED ON, ● : LED OFF, ⊙ : LED Flash

	LED						Description
	D800	D801	D802	D803	D804	D805	
Before check	⊠	●	●	●	●	●	Normal operation (no error)
During check	⊙	⊙	●	●	●	●	Checking A unit
	⊙	●	●	●	●	●	Checking B unit
	⊙	●	●	⊙	●	●	Checking C unit
	⊙	●	●	●	⊙	●	Checking D unit
	⊙	●	●	●	●	⊙	Checking E unit

⊠ : LED ON, ● : LED OFF, ⊙ : LED Flash

	LED						Description
	D800	D801	D802	D803	D804	D805	
Check results	⊠	●	●	●	●	●	Normal operation (no error)
	⊙	⊠	●	●	●	●	Trouble in unit A
	⊙	●	⊠	●	●	●	Trouble in unit B
	⊙	●	●	⊠	●	●	Trouble in unit C
	⊙	●	●	●	⊠	●	Trouble in unit D
	⊙	●	●	●	●	⊠	Trouble in unit E
	⊙	⊠	⊠	●	●	●	Trouble in units A and B
	⊙	⊠	●	⊠	●	●	Trouble in units A and C
	⊙	⊠	●	●	⊠	●	Trouble in units A and D
	⊙	⊠	●	●	●	⊠	Trouble in units A and E
	⊙	●	⊠	⊠	●	●	Trouble in units B and C
	⊙	●	⊠	●	⊠	●	Trouble in units B and D
	⊙	●	⊠	●	●	⊠	Trouble in units B and E
	⊙	●	●	⊠	⊠	●	Trouble in units C and D
	⊙	●	●	⊠	●	⊠	Trouble in units C and E
	⊙	●	●	●	⊠	⊠	Trouble in units D and E
	⊙	⊠	⊠	⊠	●	●	Trouble in units A, B, and C
	⊙	⊠	⊠	●	⊠	●	Trouble in units A, B, and D
	⊙	⊠	⊠	●	●	⊠	Trouble in units A, B, and E
	⊙	⊠	●	⊠	⊠	●	Trouble in units A, C, and D
	⊙	⊠	●	⊠	●	⊠	Trouble in units A, C, and E
	⊙	⊠	●	●	⊠	⊠	Trouble in units A, D, and E
	⊙	●	⊠	⊠	⊠	●	Trouble in units B, C, and D
	⊙	●	⊠	⊠	●	⊠	Trouble in units B, C, and E
	⊙	●	⊠	●	⊠	⊠	Trouble in units B, D, and E
	⊙	●	●	⊠	⊠	⊠	Trouble in units C, D, and E
	⊙	⊠	⊠	⊠	⊠	●	Trouble in units A, B, C, and D
	⊙	⊠	⊠	⊠	●	⊠	Trouble in units A, B, C, and E
	⊙	⊠	⊠	●	⊠	⊠	Trouble in units A, B, D, and E
	⊙	⊠	●	⊠	⊠	⊠	Trouble in units A, C, D, and E
⊙	●	⊠	⊠	⊠	⊠	Trouble in units B, C, D, and E	
⊙	⊠	⊠	⊠	⊠	⊠	"Trouble in all units Service valve stays closed"	

### ■ Gas Leak Inspection

Refer to the "■ Gas Leak Inspection" on page 6.

### ■ Test Operation

1. If you perform the test operation in summer, start running in the cooling mode first to decrease the temperature of the room, then run in the heating mode. (Heating mode: Set the temperature to 30°C.)
  - If you perform the test operation in winter, start running in the heating mode first to increase the temperature of the room, then run in the cooling mode. (Cooling mode: Set the temperature to 17°C.)
2. For the test operation, be sure to satisfy the following conditions below:
  - Perform the test operation for each indoor unit respectively.
  - Perform the test operation for about 10 minutes in both the cooling mode and the heating mode.
  - You can perform the test operation in the cooling/heating mode by utilizing the thermo sensor of the indoor unit.
    - Cooling mode: Warm the thermo sensor using an appliance such as a hair dryer.
    - Heating mode: Put a cold towel on the thermo sensor.

### ■ Instructions for the Customers

- Explain to the customers the proper operation procedure and let them operate the air conditioner along with the supplied instruction manual.
- When multiple indoor units are connected to the outdoor unit, the cooling mode and the heating mode are not available at the same time. When multiple indoor units are running at the same time, the operation mode of the unit which starts running first is applied to the other units.
- When you start running the indoor unit or change the operation mode, the unit starts running after 3 minutes. This is due to the protection function of the unit, not a malfunction.
- When the external temperature becomes low, the pre-heating of the compressor starts to protect it. Keep the circuit breaker on for use. The electricity consumption during pre-heating is about 100W. If the circuit breaker is turned off, the indoor unit may not start running for about 11 minutes.
- Electronic expansion valves are used for the outdoor unit. When you turn on the power, the outdoor unit starts clattering every 1 or 2 months. This clattering is not a malfunction, but occurs when the unit is returning to the default setting for optimised control.
- While an indoor unit is running in the heating mode, the outdoor unit supplies refrigerant to the other indoor units which are not running. Therefore, noise may come from the other indoor units or the exterior of them may become warm.



# **TOSHIBA CARRIER CORPORATION**